

VOLVO WHEEL LOADERS

# L150G, L180G, L220G

23.6-32.8t 300-371 hp





# A PASSION FOR PERFORMANCE.

At Volvo Construction Equipment, we're not just coming along for the ride. Developing products and services that raise productivity – we are confident we can lower costs and increase profits for industry experts. Part of the Volvo Group, we are passionate about innovative solutions to help you work smarter – not harder.

## Helping you to do more

Doing more with less is a trademark of Volvo Construction Equipment. High productivity has long been married to low energy consumption, ease of use and durability. When it comes to lowering life-cycle costs, Volvo is in a class of its own.

## Designed to fit your needs

There is a lot riding on creating solutions that are suited to the particular needs of different industry applications. Innovation often involves high technology – but it doesn't always have to. Some of our best ideas have been simple, based on a clear and deep understanding of our customers' working lives.



## You learn a lot in 175 years

Over the years, Volvo has advanced solutions that have revolutionized the use of construction equipment. No other name speaks Safety louder than Volvo. Protecting operators, those around them and minimizing our environmental impact are traditional values that continue to shape our product design philosophy.

## We're on your side

We back the Volvo brand with the best people. Volvo is truly a global enterprise, one that is on standby to support customers quickly and efficiently – wherever they are.

## We have a passion for performance.

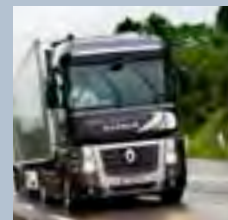
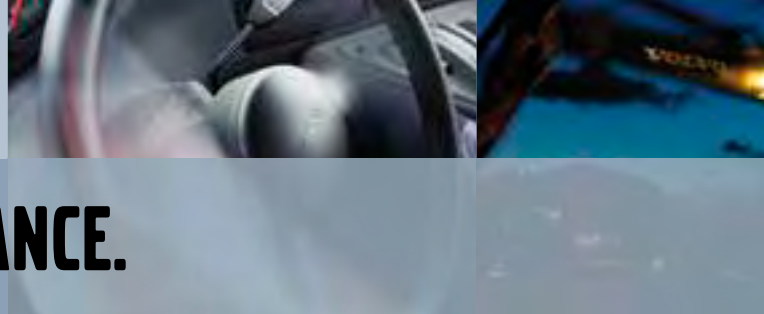

Volvo Trucks

Renault Trucks

Mack Trucks





UD Trucks

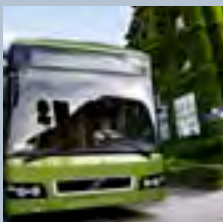

Volvo Buses



Volvo Construction Equipment



Volvo Penta



Volvo Aero

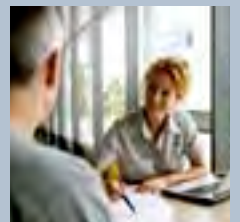

Volvo Financial Services



# LOADED, TO LIFT UP YOUR PROFITS.



Enter the cab to see and feel what makes the Volvo Care Cab a legend in comfort. Visibility is excellent to the rear and to the bucket edge. Operator controls are in ergonomically positions. Breathe and work at ease in clean, quiet comfort. It's loaded with features to keep your extended focus on profit-enhancing productivity.



#### **Volvo Care Cab**

The Volvo Care Cab provides the industry standard for operator comfort and safety. It's spacious, with plenty of foot, leg and personal space. The Volvo Care Cab applies to ROPS/FOPS standards.



### Air Filter

Breathe easier with the best cab air climate in the industry. The well placed cab air intake is placed high up to stay away from dusty air from the tires. The easy-to-replace pre-filter separates out coarse particles. Then 90% of the cab air is circulated through the main filter, resulting in very clean air.

### Excellent visibility

See it all and do it all in your Volvo wheel loader. Wide windows and narrow cab columns put you in command with clear, all-around visibility. Very good view to the attachment/corners. Improves comfort and jobsite safety, for greater productivity.



### Noise reduction

Noise and vibration dampening make for a low interior cab sound level.

### Electro hydraulic servo controls

The servo controls are mounted on the operator seat, for consistent positioning in relation to seat movements and jostles. The high quality servo controls includes for the operator easy individual settings by push button features like return to dig, boom & tilt detent and end dampening from inside the cab. Relaxed operation and comfort.

### Climate control comfort

Volvo's high sufficient climate control allows the operator to have nice cab temperature no matter the weather conditions. Select between the standard Automatic Heat Control (AHC) or optional Air Conditioning (AC). A comfortable operator is a more productive operator.



# CARRY THE LOAD EVERY DAY.

Volvo gives you all the power you need. But the true Volvo edge comes from the combination of power with efficiency, durability throughout and, above all, profitability. That's how Volvo wheel loaders help you do more every day.

## Automatic Power Shift

Automatic Power Shift (APS) operates in the ideal gear by sensing engine/ travel speed, kick down, engine braking and more. Select FAPS (fully automatic) to eliminate need for manual 1st gear kick down shifting. Results in more efficient work cycles with less wear and lower fuel consumption.

## Durable TP linkage

Volvo's patented Torque Parallel linkage delivers high breakout torque throughout the entire range, including the highest lift position. Ideal for log handling. Also provides very good parallel movement. The standard double sealed pins and bushings are designed to withstand the toughest working environments for demanding customers.



Economic working range

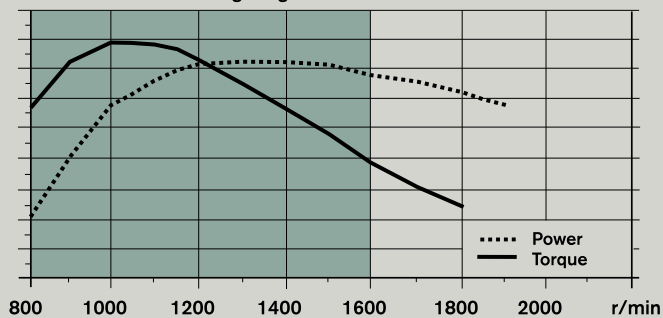

## Engine performance

The new Volvo 13 liter 6 cylinder high performance, low fuel consumption turbocharged diesel engine with high pressure unit injector system, delivering high torque at low engine speeds.





#### **Load-sensing hydraulics**

Uses variable-flow, axial piston pumps for superior control of the load and attachments. High breakout force. Faster lift and tilt functions for shorter cycle times. High capacity pumps deliver reliability, high performance/productivity and low fuel consumption.



# DESIGNED FOR PERFORMANCE.

They only judge you on what you get done. That's why Volvo L150G, L180G and L220G loaders are built to help you do more. It's where heavy-duty design meets nimble efficiency, better response and faster cycles. Meet and exceed demand in demanding conditions – day after day, year after year.

## Drive line lock-up

To prevent power loss in the torque converter, the pump rotor and turbine rotor on the torque converter lock together through a direct drive clutch. Improves drive response, rimpull performance and fuel efficiency. Better incline climbing performance and faster cycles in load & carry operations.



## Heavy duty axles

Volvo axles are the heavy-duty, axle wet brake type. The axle housings absorb all the machine/load weight distribution, allowing the axle shafts to only transmit torque to the planetary hub reductions. Reduced working stresses for longer service life.



## Reverse By Brake/OptiShift

The unique Volvo-patented Reverse By Brake (RBB) applies the standard service brake instead of the torque converter. Less loading stress on the torque converter and transmission. More fuel efficiency and deceleration comfort. Ideal for short cycle or truck loading.

OptiShift includes the torque converter with Lock-Up and Reverse By Brake. Improves loading cycles, incline climbing performance, fuel efficiency and comfort, including during deceleration.





#### **Volvo purpose-built drivetrain**

Volvo delivers a perfectly optimized, purpose-built drivetrain – built by Volvo to work together. Includes Volvo engine, transmission and axles, well matched to the hydraulic and steering system. This harmony delivers lower fuel consumption and better engine response, even at lower RPM.



# SPEND MORE TIME WORKING.

## Turbocharger

Volvo's new Turbocharger features the engine coolant continuously cooling the turbocharger bearing housing. Heat reduction is a proactive way to ensure good oil quality, long turbo life and minimum downtime.

## Contronics

Volvo Contronics is a computerized machine electronics and monitoring system. Continuously monitors the machine, operation and performance in real time. Provides diagnostic functions and information needed for optimal operation. Fast, easy electronic level checks. More uptime each day.



## Axle cradles

Maintenance-free, casted axle cradles. Rear-axle bridge connects the axle to the frame. Includes two, grease-lubricated-for-life roller bearings. Front bridge includes two oil bath, pre-filled-for-life bushings. Minimizes forces on the axle. Helps to maintain a low center of gravity.

## Battery disconnect switch

The battery disconnect switch is safely and conveniently located directly under the battery box located at the left hand side cab ladder. Quick and easy power disconnect. Saves time, money and safety concerns when service is needed or to prevent battery discharge during long shutdown periods.







The faster you can get working each day, the more you'll do and the more you'll earn. That's why Volvo wheel loaders are built with quick and easy service access, advanced monitoring and more safety. With more maintenance-free parts and components you get more worry-free reliability.



#### **Engine hood design**

Newly-designed engine hood can be electronically opened backwards. Easy opening and closing with a wide open position angle. Excellent access for fast and easy service/cleaning. Provides improved ventilation of the engine compartment.

# SMART LOAD SENSE.

## Contronics

Computerized, real-time machine diagnostics and monitoring system.



## Care Cab

ROPS/FOPS tested roomy cab with ideally placed controls and excellent operator visibility.



## Engine hood access

New electronically-opening design for ideal access and ventilation.

## Load-sensing hydraulics

Variable-flow, axial piston pumps for superior control and high breakout force.



## Eco-friendly

Low fuel consumption.

## Volvo Power

13 liter 6 cylinder water cooled turbo engine for low fuel consumption. Dependable power with high torque at low RPM.





### Servo controls

Mounted on the operator seat for comfortable operation and control.



### CareTrack\*

CareTrack is the Volvo telematics system. It is equipped as standard on this machine and is designed to provide information to help improve productivity and efficiency.

### Eco pedal

Mechanical counter pressure encourages fuel-saving ease with the accelerator pedal.



### TP linkage

Excellent link geometry for high breakout torque along with very good parallel movement.



### OptiShift

Includes the torque converter with Lock-Up and Reverse By Brake. For lower fuel consumption in most applications

### Heavy-duty axles

Absorb the weight for optimal torque, reduced stresses and longer life.

\* In markets where CareTrack is available

# HARD AT WORK, NOT ON THE PLANET.



## A lean, green machine

The environmentally-friendly Volvo engine delivers a low noise level, for more comfort inside and outside the machine. Electronic fuel injection achieves optimized power, yet low fuel consumption.



Looking out for the environment is everyone's concern. It is a core value of Volvo and built into every one of our machines. This commitment helps you work hard, but not at the expense of our planet. Lower emissions, noise and fuel usage. That's Volvo.

#### **Accelerator eco pedal**

The accelerator pedal applies an appropriate amount of mechanical counter pressure (push back) to encourage the operator to engage the pedal with ease. This economical pedal feature helps avoid unnecessarily excessive fuel use. Provides lower fuel consumption.

#### **More than 95 percent recyclable**

Volvo's core values are quality, safety and environmental care. Today, our wheel loaders are almost completely recyclable. Components such as engine, transmission and hydraulics are overhauled and re-used in our exchange system.



#### **Powerful, dependable and environmentally optimized**

With the new generation of turbocharged diesel engines, Volvo has taken yet another giant stride to maintain high fuel efficiency. Volvo provides the ability to derive high torque performance while working more efficiently at low engine speeds - reducing the depletion rate of the world's natural resources.

Quality. Safety. Environment. Volvo.

# CONNECT AND GO.

All genuine Volvo attachments are purpose-built with the same quality as the rest of the machine. They're designed as an integrated part of the wheel loader for which they were intended, their functions and properties perfectly matched to parameters such as link-arm geometry and breakout, rim pull and lifting force. That's why the machine and attachment work in perfect harmony, forming a dependable cohesive unit to get the job done – safely and efficiently.

## Rehandling buckets increase fuel efficiency:

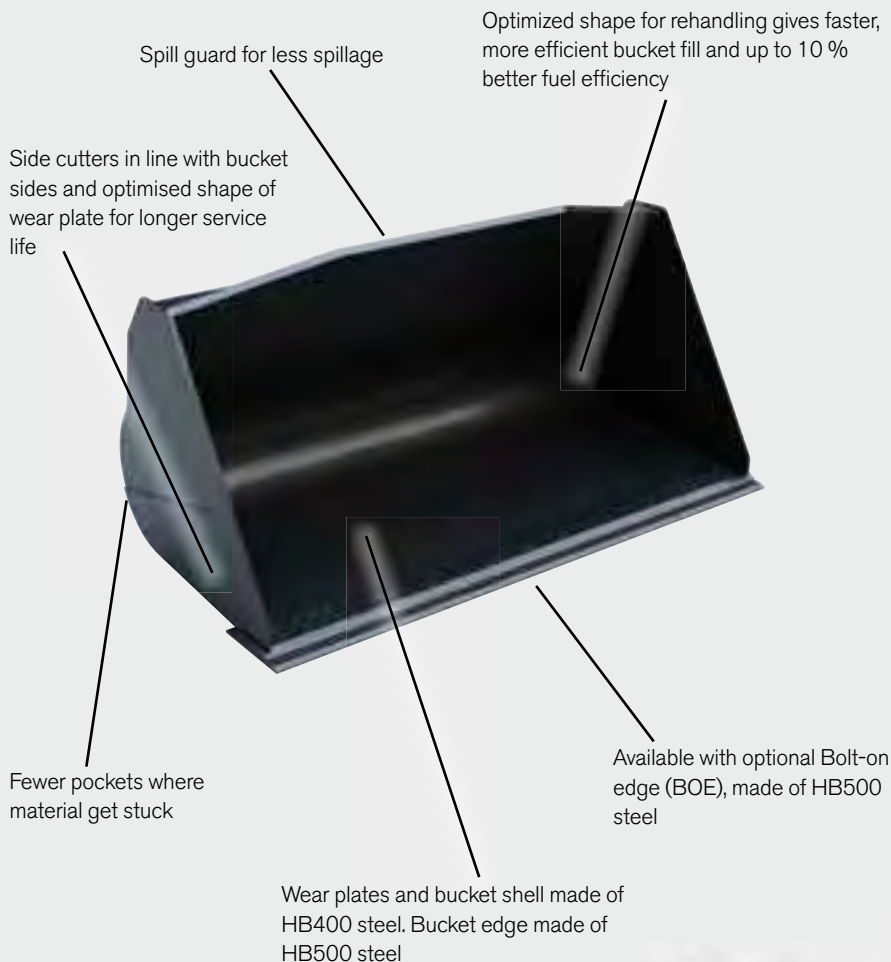

### Volvo Tooth system

The Volvo patented vertical locking device makes mounting and removing fast and easy. For Volvo buckets there are a also wide selection of cutting edges and segments in high strength steel 500 HB to protect the bucket from wear.







# TOP PERFORMANCE DESERVES SUPPORT.

The day you receive your new Volvo Wheel Loader is just the start of your working relationship with Volvo. From service and maintenance to our CareTrack telematics system – Volvo has a comprehensive and sophisticated aftermarket portfolio to continuously add value to your business.

Volvo designed and built your machines, so no-one knows how to keep them working in top condition more than us. When it comes to your machine, our Volvo trained technicians are the experts.

Our technicians work with industry leading diagnostic tools and techniques, using only Genuine Volvo Parts to deliver the highest levels of quality and service. Talk to your Volvo dealer about how genuine Volvo services can best provide the service and maintenance plan that is the right fit for you and your business.



State-of-the-art machines require state-of-the-art support and your Volvo dealer can provide a catalogue of services designed to get the most out of your machine, helping you maximise uptime, productivity and residual value. Your Volvo dealer can provide a number of sophisticated support offers, including:

Service plans ranging from routine wear inspections, through to comprehensive maintenance and repair agreements.

Analysis and diagnostics to help you understand how your machine is running, highlight potential maintenance issues and identify where performance can be improved.

Eco Operator training courses can help your operators work towards a safer, more productive and fuel efficient performance.





#### CareTrack\*

Each Volvo Wheel Loader comes standard equipped with CareTrack, the Volvo telematics system. CareTrack provides information for better planning and smarter working; including fuel consumption reports, location reports and service reminders. Save fuel. Reduce costs. Maximise profitability. You can with CareTrack.

\* In markets where CareTrack is available



# VOLVO L150G, L180G, L220G IN DETAIL.



## Engine

13 liter, 6-cylinder straight turbocharged diesel engine with 4 valves per cylinder, overhead camshaft and electronically controlled unit injectors. The engine has wet replaceable cylinder liners and replaceable valve guides and valve seats. The throttle applications is transmitted electrically from the throttle pedal or the optional hand throttle. **Air cleaning:** Three-stage Cyclone precleaner - primary filter - secondary filter. **Cooling system:** Hydrostatic, electronically controlled fan and intercooler of the air-to-air type.

### L150G

Engine		D13F-C
Max power at	r/s (r/min)	21.7 (1 300)
SAE J1995 gross	kW / hp	220 / 300
ISO 9249, SAE J1349 net	kW / hp	220 / 300
Max torque at	r/s (r/min)	17.5 (1 050)
SAE J1995 gross	Nm	1 871
ISO 9249, SAE J1349	Nm	1 869
Economic working range	r/min	800-1 600
Displacement	l	12.8

### L180G

Engine		D13F-C
Max power at	r/s (r/min)	21.7-23.3 (1 300-1 400)
SAE J1995 gross	kW / hp	246 / 334
ISO 9249, SAE J1349 net	kW / hp	245 / 333
Max torque at	r/s (r/min)	16.7 (1 000)
SAE J1995 gross	Nm	2 030
ISO 9249, SAE J1349 net	Nm	2 024
Economic working range	r/min	800-1 600
Displacement	l	12.8

### L220G

Engine		D13F-C
Max power at	r/s (r/min)	21.7-23.3 (1 300-1 400)
SAE J1995 gross	kW / hp	274 / 373
ISO 9249, SAE J1349 net	kW / hp	273 / 371
Max torque at	r/s (r/min)	18.3 (1 100)
SAE J1995 gross	Nm	2 231
ISO 9249, SAE J1349 net	Nm	2 220
Economic working range	r/min	800-1 600
Displacement	l	12.81

### L150G

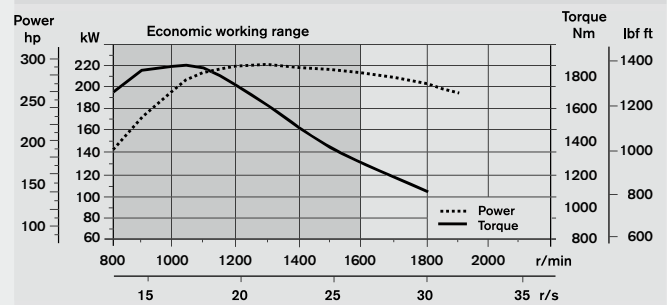

### L180G

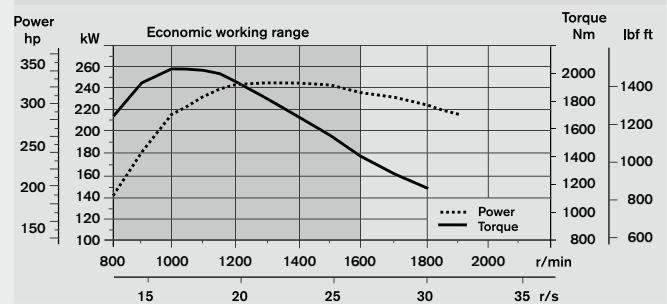

### L220G

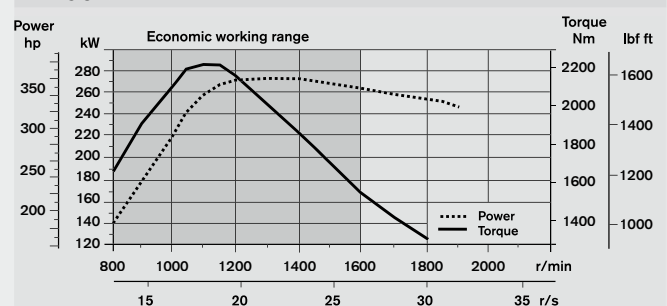





### Drivetrain

**Torque converter:** Single-stage.

**Transmission:** Volvo countershaft transmission with single lever control. Fast and smooth shifting of gears with Pulse Width Modulation (PWM) valve. Torque converter with lockup.

**Transmission:** Volvo Automatic Power Shift (APS) with fully automatic shifting 1-4 and mode selector with 4 different gear shifting programs, including AUTO.

**Axles:** Volvo fully floating axle shafts with planetary hub reductions and nodular iron axle housing. Fixed front axle and oscillating rear axle. 100% differential lock on the front axle. Optional: Limslip rear

#### L150G

Transmission	Volvo HTL 221		
Maximum speed, forward/reverse	1st gear	km/h	6.5
	2nd gear	km/h	12.5
	3rd gear	km/h	26.0
	4th gear*	km/h	38.0
Measured with tires	26.5 R25 L3		
Front axle/rear axle	Volvo/AWB 40B/40B		
Rear axle oscillation ±	°		15
Ground clearance at 15° osc.	mm		610

#### L180G

Transmission	Volvo HTL 221		
Maximum speed, forward/reverse	1st gear	km/h	6.5
	2nd gear	km/h	12.5
	3rd gear	km/h	26.0
	4th gear*	km/h	38.0
Measured with tires	26.5 R25 L3		
Front axle/rear axle	Volvo/AWB 40B/40B		
Rear axle oscillation ±	°		15
Ground clearance at 15° osc.	mm		610

#### L220G

Transmission	Volvo HTL 306		
Maximum speed, forward/reverse	1st gear	km/h	7.0
	2nd gear	km/h	12.5
	3rd gear	km/h	25
	4th gear*	km/h	38.0
Measured with tires	29.5 R25 L4		
Front axle/rear axle	Volvo/AWB 50/41		
Rear axle oscillation ±	°		15
Ground clearance at 15° osc.	mm		600

\*) limited by ECU

### Electrical system

**Central warning system:** Contronic electrical system with central warning light and buzzer for following functions: - Serious engine fault - Low steering system pressure - Over speed warning engine - Interruption in communication (computer fault) Central warning light and buzzer with the gear engaged for the following functions. - Low engine oil pressure - High engine oil temperature - High charge air temperature - Low coolant level - High coolant temperature - High crank case pressure - Low transmission oil pressure - High transmission oil temperature - Low brake pressure - Engaged parking brake - Fault on brake charging - Low hydraulic oil level - High hydraulic oil temperature - Overspeeding in engaged gear - High brake cooling oil temperature front and rear axles.

#### L150G, L180G, L220G

Voltage	V	24
Batteries	V	2 x 12
Battery capacity	Ah	2 x 170
Cold cranking capacity, approx	A	1 000
Batteries	connected to postiv terminal	
Alternator rating	W/A	2 280/80
Starter motor output	kW	7.0

### Brake system

**Service brake:** Volvo dual-circuit system with nitrogen charged accumulators. Outboard mounted hydraulically operated, fully sealed oil circulation-cooled wet disc brakes. The operator can select automatic disengagement of the transmission when braking using Contronic.

**Parking brake:** Fully sealed, wet multi-disc brake built into the transmission. Applied by spring force and electro-hydraulically release dwith a switch on the instrument panel.

**Secondary brake:** Dual brake circuits with rechargeable accumulators. One circuit or the parking brake fulfills all safety requirements..

**Standard:** The brake system complies with the requirements of ISO 3450.

#### L150G

Number of brake discs per wheel front/rear	front 1	
Accumulators	l	2x1.0 3x0.5

#### L180G

Number of brake discs per wheel front/rear	front 1	
Accumulators	l	2x1.0 1x0.5

#### L220G

Number of brake discs per wheel front/rear	front 2	
Accumulators	l	2x1.0 1x0.5

# VOLVO L150G, L180G, L220G IN DETAIL



## Cab

**Instrumentation:** All important information is centrally located in the operator's field of vision. Display for Contronic monitoring system.

**Heater and defroster:** Heater coil with filtered fresh air and fan with auto and 11 speeds. Defroster vents for all window areas.

**Operator's seat:** Operator's seat with adjustable suspension and retractable seatbelt. The seat is mounted on a bracket on the rear cab wall and floor. The forces from the retractable seatbelt are absorbed by the seat rails.

**Standard:** The cab is tested and approved according to ROPS (ISO 3471), FOPS (ISO 3449). The cab meets with requirements according to ISO 6055 (Operator overhead protection - Industrial trucks) and SAE J386 ("Operator Restraint System").

		<b>L150G</b>
Emergency exit:	Use emergency hammer to break window	
Sound level in cab according to ISO 6396/SAE J2105		
LpA	dB(A)	69
External sound level according to ISO 6395/SAE J2104		
LwA	dB(A)	108
Ventilation	m <sup>3</sup> /min	9
Heating capacity	kW	16
Air conditioning (optional)	kW	7.5

		<b>L180G</b>
Emergency exit:	Use emergency hammer to break window	
Sound level in cab according to ISO 6396/SAE J2105		
LpA	dB(A)	70
External sound level according to ISO 6395/SAE J2104		
LwA	dB(A)	108
Ventilation	m <sup>3</sup> /min	9
Heating capacity	kW	16
Air conditioning (optional)	kW	7.5

		<b>L220G</b>
Emergency exit:	Use emergency hammer to break window	
Sound level in cab according to ISO 6396/SAE J2105		
LpA	dB(A)	70
External sound level according to ISO 6395/SAE J2104		
LwA	dB(A)	109
Ventilation	m <sup>3</sup> /min	9
Heating capacity	kW	16
Air conditioning (optional)	kW	7.5

## Lift arm system

Torque Parallel linkage (TP-linkage) with high breakout torque and parallel action throughout the entire lifting range.

		<b>L150G</b>
Lift cylinders		2
Cylinder bore	mm	160
Piston rod diameter	mm	90
Stroke	mm	784
Tilt cylinder		1
Cylinder bore	mm	220
Piston rod diameter	mm	110
Stroke	mm	452

		<b>L180G</b>
Lift cylinders		2
Cylinder bore	mm	180
Piston rod diameter	mm	90
Stroke	mm	788
Tilt cylinder		1
Cylinder bore	mm	240
Piston rod diameter	mm	120
Stroke	mm	480

		<b>L220G</b>
Lift cylinders		2
Cylinder bore	mm	190
Piston rod diameter	mm	90
Stroke	mm	768
Tilt cylinder		1
Cylinder bore	mm	250
Piston rod diameter	mm	120
Stroke	mm	455





### Hydraulic system

**System supply:** Two load-sensing axial piston pumps with variable displacement. The steering function always has priority.

**Valves:** Double-acting 2-spool valve. The main valve is controlled by pilot pressure and electric servo (L150G) i.e. by a 2-spool pilot valve (L180G/L220G).

**Lift function:** The valve has three positions: raise, hold and lower position. Inductive/magnetic automatic boom kickout can be switched on and off and is adjustable to any position between maximum reach and full lifting height.

**Tilt function:** The valve has three functions including rollback, hold and dump. Inductive/magnetic automatic tilt can be adjusted to the desired bucket angle.

**Cylinders:** Double-acting cylinders for all functions.

**Filter:** Full flow filtration through 10 micron (absolute) filter cartridge.

		L150G	L180G	L220G
Working pressure maximum, pump 1	MPa	29.0	29.0	29.0
Flow at engine speed	l/min	180	217	253
	MPa	10	10	10
Working pressure maximum, pump 2	MPa	31.0	31.0	31.0
Flow at engine speed	l/min	202	202	202
	MPa	10	10	10
Working pressure maximum, pump 3	MPa	25.0	25.0	25.0
Flow at engine speed	l/min	77	77	77
	MPa	10	10	10
Pilot system, working pressure	MPa	3.5	3.5	3.5
Cycle times				
Lift	s	5.9	6.4	6.8
Tilt*	s	2.0	1.8	1.6
Lower, empty	s	3.7	3.3	3.2
Total cycle time	s	11.6	11.5	10.6

### Steering system

**Steering system:** Load-sensing hydrostatic articulated steering.

**System supply:** The steering system has priority feed from a load-sensing axial piston pump with variable displacement.

**Steering cylinders:** Two double-acting cylinders.

		L150G	L180G	L220G
Steering cylinders		2	2	2
Cylinder bore	mm	100	100	100
Rod diameter	mm	60	60	60
Stroke	mm	390	525	525
Working pressure	MPa	21	21	21
Maximum flow	l/min	188	188	191
Maximum articulation	± °	37	37	37

### Service

**Service accessibility:** Large, easy-to-open hood covering whole engine department, electrically operated. Fluid filters and component breather air filters promote long service intervals. Possibility to monitor, log and analyze data to facilitate troubleshooting.

		L150G	L180G	L220G
Fuel Tank	l	335	335	335
Engine coolant	l	46	46	46
Hydraulic oil tank	l	156	156	226
Transmission oil	l	48	48	48
Engine oil	l	50	50	50
Axle oil front/rear	l	45/55	45/55	77/71

# SPECIFICATIONS.

Tires L150G, L180G: 26.5 R25 L3. Tires L220G: 29.5 R25 L4

		Standard boom			Long boom		
		L150G	L180G	L220G	L150G	L180G	L220G
B	mm	7 070	7 190	7 480	7 570	7 620	7 800
C	mm	3 550	3 550	3 700	3 550	3 550	3 700
D	mm	470	480	540	460	480	540
F	mm	3 570	3 580	3 740	3 560	3 580	3 740
G	mm	2 134	2 134	2 131	2 134	2 133	2 133
J	mm	3 910	4 050	4 240	4 480	4 540	4 600
K	mm	4 320	4 470	4 670	4 890	4 960	5 030
O	°	58	57	56	59	55	56
P <sub>max</sub>	°	50	49	48	49	49	48
R	°	45	45	43	48	49	44
R <sub>1</sub> *	°	48	48	47	53	53	49
S	°	66	71	65	61	63	63
T	mm	106	140	111	161	223	117
U	mm	510	550	590	630	650	670
X	mm	2 280	2 280	2 400	2 280	2 280	2 400
Y	mm	2 960	2 960	3 170	2 960	2 960	3 170
Z	mm	3 490	3 810	4 060	3 950	4 170	4 390
a <sub>2</sub>	mm	6 780	6 780	7 110	6 780	6 780	7 110
a <sub>3</sub>	mm	3 830	3 830	3 940	3 830	3 830	3 940
a <sub>4</sub>	±°	37	37	37	37	37	37

\* Carry position SAE

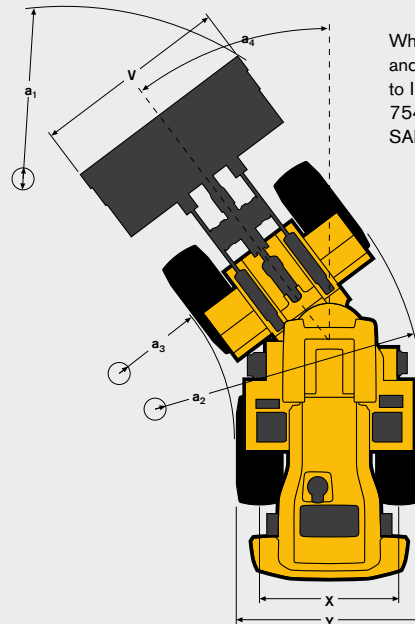
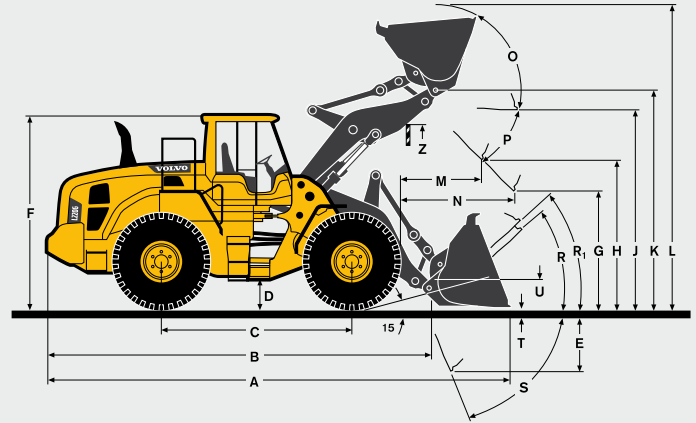

Where applicable, specifications and dimensions are according to ISO 7131, SAE J732, ISO 7546, SAE J742, ISO 14397, SAE J818.

- L150G** Sales code: WLA80713  
Operating weight (incl. logging cw 1 140 kg): 25 660 kg  
Operating load: 7 700 kg
- L180G** Sales code: WLA80027  
Operating weight (incl. logging cw 1 140 kg): 28 470 kg  
Operating load: 8 710 kg
- L220G** Sales code: WLA80852  
Operating weight (incl. logging cw 870 kg): 32 810 kg  
Operating load: 10 080 kg

Tires L150G, L180G: 775/65 R29 L3





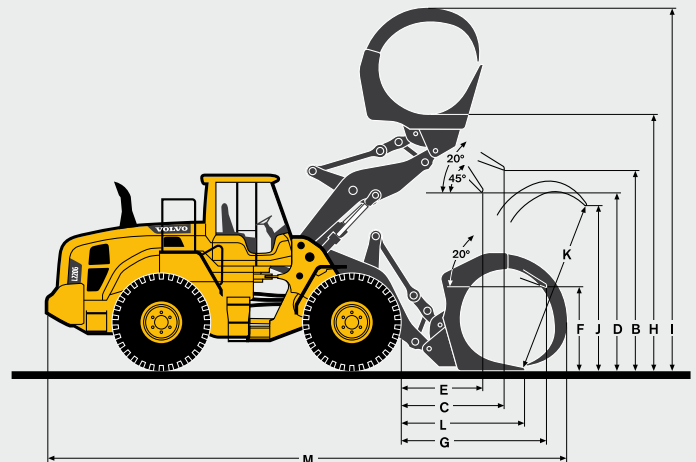



Tires L220G: 875/65 R29 L4

		L150G	L180G	L220G
A	m <sup>2</sup>	3.1	3.5	4.0
B	mm	3 660	3 870	3 920
C	mm	2 110	2 150	2 270
D	mm	2 960	3 150	3 160
E	mm	1 650	1 720	1 780
F	mm	1 630	1 700	1 640
G	mm	2 930	3 040	3 230
H	mm	4 990	5 170	5 350
I	mm	7 270	7 610	7 730
J	mm	3 080	3 370	3 620
K	mm	3 340	3 710	3 940
L	mm	2 290	2 410	2 630
M	mm	9 680	9 980	10 380





**L150G**

Tires 26.5 R25 L3	REHANDLING				GENERAL PURPOSE			ROCK*	LIGHT MATERIAL	LONG BOOM	
											
	4 m³ STE P BOE	4.4 m³ STE P BOE	4.8 m³ STE P BOE	5.2 m³ STE P BOE	4 m³ STE P T SEG	4.4 m³ STE P T SEG	4.5 m³ STE P T SEG	3.5 m³ SPN P T SEG	6.8 m³ LM P		
Volume, heaped ISO/SAE	m³	4.0	4.4	4.8	5.2	4.0	4.4	4.5	3.5	6.8	-
Volume at 110% fill factor	m³	4.4	4.8	5.3	5.7	4.4	4.8	5.0	3.9	7.5	-
Static tipping load, straight	kg	19 850	19 590	19 310	19 160	17 610	17 230	17 620	18 300	16 550	-3 490
at 35° turn	kg	17 700	17 440	17 170	17 020	15 710	15 330	15 710	16 320	14 710	-3 210
at full turn	kg	17 460	17 200	16 920	16 780	15 500	15 110	15 490	16 090	14 500	-3 180
Breakout force	kN	201.1	191.5	183.2	182.6	202.0	192.7	190.5	187.9	146.6	9
A	mm	8 590	8 670	8 740	8 750	8 800	8 880	8 890	8 850	9 140	510
E	mm	1 230	1 300	1 360	1 370	1 410	1 480	1 500	1 450	1 710	10
H**)	mm	3 030	2 970	2 920	2 920	2 880	2 830	2 820	2 870	2 620	570
L	mm	5 730	5 780	5 880	5 870	5 870	5 980	5 890	5 980	6 090	560
M**)	mm	1 220	1 270	1 320	1 320	1 350	1 400	1 410	1 420	1 560	-20
N**)	mm	1 800	1 830	1 860	1 860	1 870	1 890	1 900	1 930	1 940	450
V	mm	3 200	3 200	3 200	3 400	3 230	3 230	3 000	3 230	3 200	-
a1 clearance circle	mm	14 640	14 670	14 700	14 890	14 750	14 790	14 580	14 800	14 900	-
Operating weight	kg	24 490	24 700	24 890	25 020	23 680	24 020	23 780	24 930	23 990	410





\*) With L5 tires

\*\*) Measured to the tip of the bucket teeth or bolt-on edge. Dump height to bucket edge. Measured at 45° dump angle. (Spade nose buckets at 42°.)

Note: This only applies to genuine Volvo attachments.

**Bucket Selection Chart**

The chosen bucket is determined by the density of the material and the expected bucket fill factor. The actual bucket volume is often larger than the rated capacity, due to the features of the TP linkage, including an open bucket design, good rollback angles in all positions and good bucket filling performance. The example represents a standard boom configuration.  
 Example: Sand and gravel. Fill factor ~ 105%. Density 1.6 t/m³.  
 Result: The 4.0 m³ bucket carries 4.2 m³. For optimum stability always consult the bucket selection chart.

Material	Bucket fill, %		Material density, t/m³	ISO/SAE bucket volume, m³	Actual volume, m³
Earth/Clay	~ 110		~ 1.6	4.0	~ 4.4
			~ 1.5	4.4	~ 4.8
Sand/Gravel	~ 105		~ 1.6	4.0	~ 4.2
			~ 1.5	4.4	~ 4.6
Aggregate	~ 100		~ 1.8	4.4	~ 4.4
			~ 1.7	4.8	~ 4.8
			~ 1.5	5.2	~ 5.2
Rock	≤100		~ 1.7	3.5	~ 3.5

The size of rock buckets is optimized for optimal penetration and filling capability rather than the density of the material.

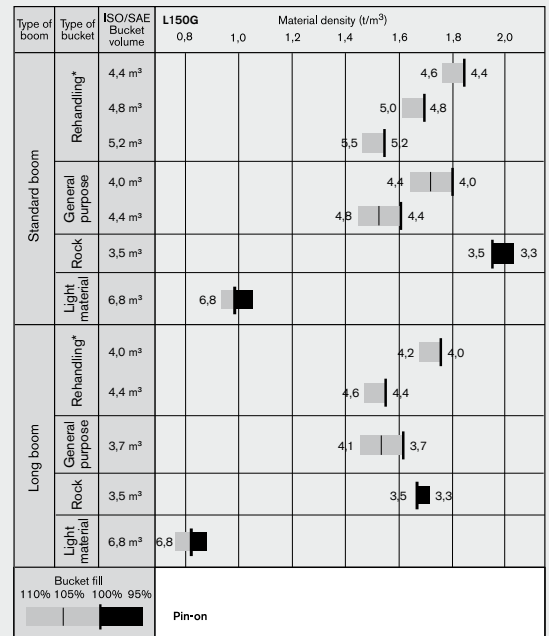

How to read bucket fill factor









\* Including counterweight

**Supplemental Operating Data**

Tires 26.5 R25 L3	Standard boom			Long boom			
	26.5 R25 L4	26.5 R25 L5	775/65 R29 L3	26.5 R25 L4	26.5 R25 L5	775/65 R29 L3	
Width over tires	mm	+5	+30	+180	+5	+30	+180
Ground clearance	mm	+18	+30	+10	+18	+30	+10
Tipping load, full turn	kg	+250	+760	+590	+220	+640	+500
Operating weight	kg	+400	+1 060	+760	+400	+1 050	+750

# SPECIFICATIONS.

## L180G





Tires 26.5 R25 L3	REHANDLING				GENERAL PURPOSE			ROCK*	LIGHT MATERIAL	LONG BOOM	
	 4.8 m³ STE P BOE	 5.2 m³ STE P BOE	 5.5 m³ STE P BOE	 5.8 m³ STE P BOE	 4.4 m³ STE P T SEG	 4.6 m³ STE P T SEG	 4.8 m³ STE P T SEG	 4.2 m³ SPN P T SEG	 7.8 m³ LM P		
Volume, heaped ISO/SAE	m³	4.8	5.2	5.5	5.8	4.4	4.6	4.8	4.2	7.8	-
Volume at 110% fill factor	m³	5.3	5.7	6.1	6.4	4.8	5.1	5.3	4.6	8.6	-
Static tipping load, straight	kg	22 930	22 780	22 610	22 480	21 080	21 100	20 900	21 650	19 710	-3 760
at 35° turn	kg	20 310	20 160	20 000	19 870	18 700	18 710	18 520	19 190	17 390	-3 430
at full turn	kg	20 010	19 870	19 700	19 580	18 420	18 440	18 250	18 910	17 130	-3 390
Breakout force	kN	224.8	224.2	216.2	209.9	236.3	236.3	226.7	212.6	173.4	4
A	mm	8 890	8 890	8 960	9 010	9 010	9 010	9 080	9 140	9 360	470
E	mm	1 420	1 430	1 490	1 540	1 540	1 540	1 600	1 650	1 860	20
H**)	mm	3 060	3 060	3 010	2 980	2 970	2 970	2 930	2 910	2 700	500
L	mm	6 020	6 010	6 040	6 110	6 120	6 170	6 170	6 320	6 300	490
M**)	mm	1 330	1 340	1 380	1 410	1 410	1 410	1 460	1 520	1 610	20
N**)	mm	1 960	1 970	1 990	2 010	2 000	2 000	2 030	2 080	2 060	420
V	mm	3 200	3 400	3 400	3 400	3 230	3 230	3 230	3 230	3 400	-
a1 clearance circle	mm	14 800	14 990	15 010	15 040	14 880	14 880	14 910	14 960	15 220	-
Operating weight	kg	27 340	27 460	27 560	27 630	26 460	26 500	26 560	27 720	26 740	310

\*) With L5 tires  
\*\*) Measured to the tip of the bucket teeth or bolt-on edge. Dump height to bucket edge. Measured at 45° dump angle. (Spade nose buckets at 42°)

Note: This only applies to genuine Volvo attachments.

### Bucket Selection Chart

The chosen bucket is determined by the density of the material and the expected bucket fill factor. The actual bucket volume is often larger than the rated capacity, due to the features of the TP linkage, including an open bucket design, good rollback angles in all positions and good bucket filling performance. The example represents a standard boom configuration.  
Example: Sand and gravel. Fill factor ~ 105%. Density 1.6 t/m³.  
Result: The 4.6 m³ bucket carries 4.8 m³. For optimum stability always consult the bucket selection chart.

Material	Bucket fill, %		Material density, t/m³	ISO/SAE bucket volume, m³	Actual volume, m³
Earth/Clay	~ 110		~ 1.7	4.4	~ 4.8
			~ 1.6	4.6	~ 5.1
			~ 1.5	4.8	~ 5.3
Sand/Gravel	~ 105		~ 1.7	4.4	~ 4.6
			~ 1.6	4.6	~ 4.8
			~ 1.5	4.8	~ 5.1
Aggregate	~ 100		~ 1.8	5.2	~ 5.2
			~ 1.7	5.5	~ 5.5
			~ 1.6	5.8	~ 5.8
Rock	≤100		~ 1.7	4.3	~ 4.3

The size of rock buckets is optimized for optimal penetration and filling capability rather than the density of the material.

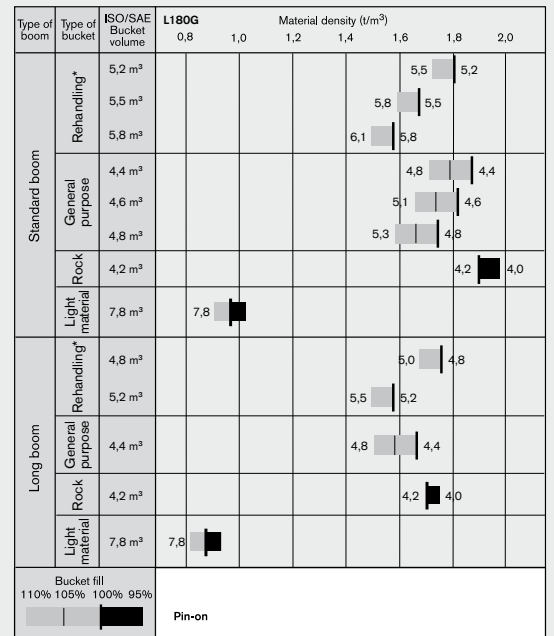

How to read bucket fill factor

\* Including counterweight

### Supplemental Operating Data

Tires 26.5 R25 L3	Standard boom			Long boom			
	26.5 R25 L4	26.5 R25 L5	775/65 R29 L3	26.5 R25 L4	26.5 R25 L5	775/65 R29 L3	
Width over tires	mm	+5	+30	+130	+5	+30	+130
Ground clearance	mm	+18	+40	+10	+18	+40	+10
Tipping load, full turn	kg	+280	+770	+600	+250	+760	+530
Operating weight	kg	+400	+1 050	+920	+400	+1 050	+1 120



**L220G**

Tires 29.5 R25 L4	REHANDLING			GENERAL PURPOSE			ROCK*		LIGHT MATERIAL	LONG BOOM	
Additional machine specification	5.6 m³ STE P BOE	5.9 m³ STE P BOE	6.3 m³ STE P BOE	4.9 m³ STE P T SEG	5.2 m³ STE P T SEG	5.6 m³ STE P T SEG	4.5 m³ SPN P T SEG	5.0 m³ SPN P T SEG	8.2 m³ LM P		
Volume, heaped ISO/SAE	m³	5.6	5.9	6.3	4.9	5.2	5.6	4.5	5.0	8.2	-
Volume at 110% fill factor	m³	6.2	6.5	6.9	5.4	5.7	6.2	5.0	5.5	9.0	-
Static tipping load, straight	kg	24 850	24 720	24 540	23 660	23 520	23 250	24 000	23 170	22 520	-2 870
at 35° turn	kg	22 080	21 950	21 780	21 040	20 900	20 650	21 340	20 580	19 950	-2 640
at full turn	kg	21 760	21 640	21 470	20 740	20 600	20 350	21 040	20 280	19 660	-2 610
Breakout force	kN	228.2	222.5	214.4	255.2	248.1	231.9	212.0	196.6	190.3	4
A	mm	9 240	9 290	9 360	9 290	9 340	9 440	9 580	9 730	9 560	310
E	mm	1 440	1 480	1 550	1 480	1 520	1 620	1 730	1 860	1 730	-20
H**)	mm	3 190	3 160	3 110	3 160	3 120	3 060	3 030	2 930	2 940	360
L	mm	6 290	6 310	6 400	6 390	6 450	6 460	6 420	6 500	6 480	370
M**)	mm	1 380	1 410	1 460	1 410	1 440	1 520	1 690	1 800	1 580	-30
N**)	mm	2 090	2 110	2 140	2 100	2 120	2 180	2 250	2 300	2 170	270
V	mm	3 400	3 400	3 400	3 430	3 430	3 430	3 430	3 430	3 700	-
a1 clearance circle	mm	15 560	15 580	15 620	15 610	15 630	15 690	15 770	15 850	16 010	-
Operating weight	kg	32 280	32 360	32 470	31 550	31 640	31 680	32 990	33 160	32 040	390

\*) With L5 tires

Note: This only applies to genuine Volvo attachments.

\*\* ) Measured to the tip of the bucket teeth or bolt-on edge. Dump height to bucket edge. Measured at 45° dump angle. (Spade nose buckets at 42°.)

**Bucket Selection Chart**

The chosen bucket is determined by the density of the material and the expected bucket fill factor. The actual bucket volume is often larger than the rated capacity, due to the features of the TP linkage, including an open bucket design, good rollback angles in all positions and good bucket filling performance. The example represents a standard boom configuration.  
 Example: Sand and gravel. Fill factor ~ 105%. Density 1.6 t/m³.  
 Result: The 5.2 m³ bucket carries 5.5 m³. For optimum stability always consult the bucket selection chart.

Material	Bucket fill, %		Material density, t/m³	ISO/SAE bucket volume, m³	Actual volume, m³
Earth/Clay	~ 110		~ 1.6	4.9	~ 5.4
			~ 1.5	5.2	~ 5.7
			~ 1.4	5.4	~ 5.9
Sand/Gravel	~ 105		~ 1.7	4.9	~ 5.1
			~ 1.6	5.2	~ 5.5
			~ 1.5	5.4	~ 5.7
Aggregate	~ 100		~ 1.8	5.6	~ 5.6
			~ 1.7	5.9	~ 5.9
			~ 1.6	6.3	~ 6.3
Rock	≤100		~ 1.7	4.5	~ 4.5

The size of rock buckets is optimized for optimal penetration and filling capability rather than the density of the material.

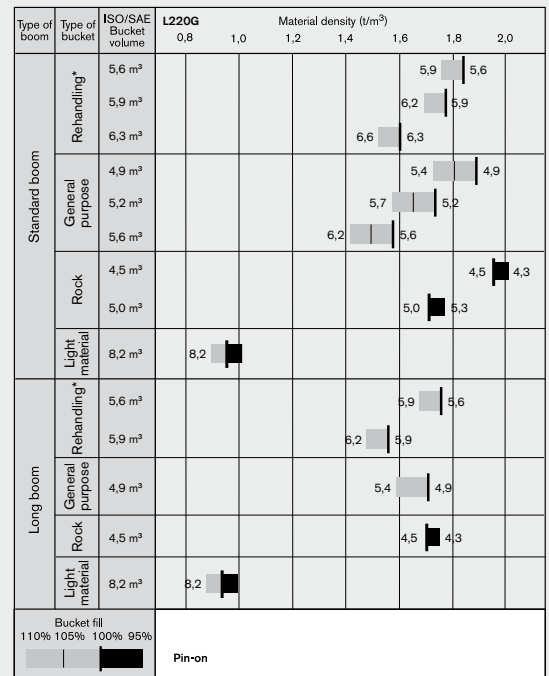

How to read bucket fill factor

\* Including counterweight

**Supplemental Operating Data**

Tires 29.5 R25 L4	Standard boom			Long boom			
	29.5 R25 L3	29.5 R25 L5	875/65 R29 L4	29.5 R25 L3	29.5 R25 L5	875/65 R29 L4	
Width over tires	mm	-20	+35	+95	-20	+35	+95
Ground clearance	mm	±0	+40	-10	±0	+40	-20
Tipping load, full turn	kg	-100	+1 010	+180	-90	+930	+180
Operating weight	kg	-80	+1 490	+650	-80	+1 500	+650

# EQUIPMENT.

## STANDARD EQUIPMENT

	L150G	L180G	L220G
<b>Service and maintenance</b>			
Engine oil remote drain and fill	•	•	•
Transmission oil remote drain and fill	•	•	•
Lubrication manifolds, ground accessible	•	•	•
Pressure check connections: transmission and hydraulic, quick-connects	•	•	•
Tool box, lockable	•	•	•
CareTrack	•	•	•
Telematics, 3-Year Subscription	•	•	•
<b>Engine</b>			
Three stage air cleaner, pre-cleaner, primary and secondary filter	•	•	•
Indicator glass for coolant level	•	•	•
Preheating of induction air	•	•	•
Fuel pre-filter with water trap	•	•	•
Fuel filter	•	•	•
Crankcase breather oil trap	•	•	•
Exhaust heat insulation	•	•	•
Exterior radiator air intake protection	•	•	•
<b>Electrical system</b>			
24 V, pre-wired for optional accessories	•	•	•
Alternator 24V/ 80A	•	•	•
Battery disconnect switch with removable key	•	•	•
Fuel gauge	•	•	•
Hour meter	•	•	•
Electric horn	•	•	•
Instrument cluster:	•	•	•
• Fuel level			
• Transmission temperature			
• Coolant temperature			
• Instrument lighting			
Lighting:	•	•	•
• Twin halogen front headlights with high and low beams			
• Parking lights			
• Double brake and tail lights			
• Turn signals with flashing hazard light function			
• Halogen work lights (2 front and 2 rear)			
<b>Contronic monitoring system</b>			
Monitoring and logging of machine data	•	•	•
Contronic display	•	•	•
Fuel consumption	•	•	•
Ambient temperature	•	•	•
Clock	•	•	•
Test function for warning and indicator lights	•	•	•
Brake test	•	•	•
Test function, sound level at max fan speed	•	•	•
Warning and indicator lights:	•	•	•
• Battery charging			
• Parking brake			
Warning and display message:	•	•	•
• Engine coolant temperature			
• Charge-air temperature			
• Engine oil temperature			
• Engine oil pressure			
• Transmission oil temperature			
• Transmission oil pressure			
• Hydraulic oil temperature			
• Brake pressure			
• Parking brake applied			
• Brake charging			
• Overspeed at direction change			
• Axle oil temperature			
• Steering pressure			
• Crankcase pressure			
• Attachment lock open			
Level warnings:	•	•	•
• Fuel level			
• Engine oil level			
• Engine coolant level			
• Transmission oil level			
• Hydraulic oil level			
• Washer fluid level			
Engine torque reduction in case of malfunction indication:	•	•	•
• High engine coolant temperature			
• High engine oil temperature			
• Low engine oil pressure			
• High crankcase pressure			
• High charge-air temperature			

Engine shutdown to idle in case of malfunction indication:	•	•	•
• High transmission oil temperature			
• Slip in transmission clutches			
Keypad, background lit	•	•	•
Start interlock when gear is engaged	•	•	•
<b>Drivetrain</b>			
Automatic Power Shift	•	•	•
Fully automatic gearshifting, 1-4	•	•	•
PWM-controlled gearshifting	•	•	•
Forward and reverse switch by hydraulic lever console	•	•	•
Indicator glass for transmission oil level	•	•	•
Differentials:	•	•	•
Front, 100% hydraulic diff lock. Rear, conventional.			
OptiShift	•	•	•
<b>Brake system</b>			
Dual brake circuits	•	•	•
Dual brake pedals	•	•	•
Secondary brake system	•	•	•
Parking brake, electrical-hydraulic	•	•	•
Brake wear indicators	•	•	•
<b>Cab</b>			
ROPS (ISO 3471), FOPS (ISO 3449)	•	•	•
Single key kit door/start	•	•	•
Acoustic inner lining	•	•	•
Ashtray	•	•	•
Cigarette lighter, 24 V power outlet	•	•	•
Lockable door	•	•	•
Cab heating with fresh air inlet and defroster	•	•	•
Fresh air inlet with two filters	•	•	•
Automatic heat control	•	•	•
Floor mat	•	•	•
Dual interior lights	•	•	•
Dual interior rear-view mirrors	•	•	•
Dual exterior rear-view mirrors	•	•	•
Sliding window, right side	•	•	•
Tinted safety glass	•	•	•
Retractable seatbelt (SAE J386)	•	•	•
Adjustable steering wheel	•	•	•
Storage compartment	•	•	•
Document pocket	•	•	•
Sun visor	•	•	•
Beverage holder	•	•	•
Windshield washer front and rear	•	•	•
Windshield wipers front and rear	•	•	•
Interval function for front and rear wipers	•	•	•
<b>Hydraulic system</b>			
Main valve, double acting 2-spool with hydraulic pilots	•	•	•
Variable displacement axial piston pumps (3) for:	•	•	•
1 Working hydraulic system			
2 Working hydraulic system,			
Steering- and Brake system			
3 Cooling fan and Brake system			
Electro-hydraulic servo controls	•	•	•
Electric level lock	•	•	•
Boom kick-out, automatic	•	•	•
Bucket positioner, automatic	•	•	•
Double-acting hydraulic cylinders	•	•	•
Indicator glass for hydraulic oil level	•	•	•
Hydraulic oil cooler	•	•	•
<b>External equipment</b>			
Fenders, front and rear	•	•	•
Viscous cab mounts	•	•	•
Rubber engine and transmission mounts	•	•	•
Easy-to-open engine hood	•	•	•
Frame, joint lock	•	•	•
Vandalism lock prepared for	•	•	•
• Batteries			
• Engine compartment			
• Radiator grille			
Lifting eyes	•	•	•
Tie-down eyes	•	•	•
Tow hitch	•	•	•
Counterweight, pre-drilled for optional guards	•	•	•



## OPTIONAL EQUIPMENT

	L150G	L180G	L220G
<b>Service and maintenance</b>			
Automatic lubrication system	•	•	•
Automatic lubrication system for long boom	•	•	•
Grease nipple guards	•	•	•
Oil sampling valve	•	•	•
Refill pump for grease to lube system	•	•	•
Tool kit	•	•	•
Wheel nut wrench kit	•	•	•
<b>Engine</b>			
Air pre-cleaner, cyclone type	•	•	•
Air pre-cleaner, cyclone type, two-stage	•	•	•
Air pre-cleaner, oil-bath type	•	•	•
Air pre-cleaner, turbo type	•	•	•
Radiator corrosion protection	•	•	•
Engine auto shutdown	•	•	•
Engine block heater 230V/110V	•	•	•
ESW, Disabled engine protection	•	•	•
Air intake protection (for grill in waste)	•	•	•
Fuel fill strainer	•	•	•
Fuel heater	•	•	•
Hand throttle control	•	•	•
Max. fan speed, hot climate	•	•	•
Radiator, corrosion-protected	•	•	•
Reversible cooling fan	•	•	•
Reversible cooling fan and axle oil cooler	•	•	•
Fuel filter, extra	•	•	•
<b>Electrical system</b>			
Alternator, 80 A with air filter	•	•	•
Anti-theft device	•	•	•
Headlights, assym. left	•	•	•
License plate holder, lighting	•	•	•
Rear view camera incl. monitor, colour	•	•	•
Rear-view mirrors, adjustable, el.heated	•	•	•
Rear view mirrors, Long arm	•	•	•
Rear view mirrors, adjustable, el.heated, Long arm	•	•	•
Reduced function working lights, reverse gear activated	•	•	•
Reverse alarm	•	•	•
Reverse warning light, strobe lighting	•	•	•
Shortened headlight support brackets	•	•	•
Side marker lamps	•	•	•
Rotating beacon	•	•	•
Working lights, attachments	•	•	•
Working lights front, high intensity discharge (HID)	•	•	•
Working lights front, on cab, dual	•	•	•
Working lights front, extra	•	•	•
Working lights rear, on cab	•	•	•
Working lights rear, on cab, dual	•	•	•
<b>Cab</b>			
Anchorage for Operator's manual	•	•	•
Automatic Climate Control, ACC	•	•	•
ACC control panel, with Fahrenheit scale	•	•	•
Asbestos dust protection filter	•	•	•
Cab air pre-cleaner, cyclone type	•	•	•
Carbon filter	•	•	•
Cab roof, heavy-duty	•	•	•
Cover plate, under cab	•	•	•
Lunch box holder	•	•	•
Armrest, operator's seat, ISRI, left only	•	•	•
Operator's seat, KAB, air susp, heavy-duty, for CDC and/or elsevo	•	•	•
Operator's seat, ISRI, air susp, heat, high back	•	•	•
Radio installation kit incl. 11 amp 12 volt outlet, left side	•	•	•
Radio installation kit incl. 11 amp 12 volt outlet, right side	•	•	•
Radio installation kit incl. 20 amp 12 volt outlet	•	•	•
Radio with CD-player	•	•	•
Seatbelt, 3", (width 75 mm)	•	•	•
Steering wheel knob	•	•	•
Sun blinds, rear windows	•	•	•
Sun blinds, side windows	•	•	•
Timer cab heating	•	•	•
Window, sliding, door	•	•	•
Universal door/ignition key	•	•	•
Front view mirror	•	•	•

<b>Drivetrain</b>			
Diff lock front 100%, Limited Slip rear	•	•	•
Speed limiter, 20 km/h	•	•	•
Speed limiter, 30 km/h	•	•	•
Speed limiter, 40 km/h	•	•	•
Wheel/axle seal guards	•	•	•
<b>Brake system</b>			
Oil cooler and filter front & rear axle	•	•	•
Stainless steel, brake lines	•	•	•
<b>Hydraulic system</b>			
Attachment bracket, welded	•	•	•
Boom suspension system	•	•	•
Separate attachment locking, standard boom	•	•	•
Separate attachment locking, long boom	•	•	•
Arctic kit, attachment locking hoses and 3rd hydr. function	•	•	•
Arctic kit, pilot hoses and brake accum. incl. hydr. oil	•	•	•
Boom cylinder hose and tube guards	•	•	•
Boom cylinder hose and tube guards for long boom	•	•	•
Hydraulic fluid, biodegradable, Volvo	•	•	•
Hydraulic fluid, fire-resistant	•	•	•
Hydraulic fluid, for hot climate	•	•	•
Electro-hydraulic function, 3rd	•	•	•
Electro-hydraulic function, 3rd for long boom	•	•	•
Electro-hydraulic function, 3rd-4th	•	•	•
Electro-hydraulic function, 3rd-4th for long boom	•	•	•
Electro-hydraulic servo controls for long boom	•	•	•
<b>External equipment</b>			
Cab ladder, rubber-suspended	•	•	•
Deleted front mudguards	•	•	•
Mudguard widener, front/rear for 80-series tires	•	•	•
Mudguard widener, front/rear for 65-series tires	•	•	•
Fire suppression system	•	•	•
Mudguards, full cover, rear for 80-series tires	•	•	•
Mudguards, full cover, rear for 65-series tires	•	•	•
Long boom	•	•	•
<b>Protective equipment</b>			
Belly guard front	•	•	•
Belly guard rear	•	•	•
Belly guard rear, oil pan	•	•	•
Cover plate, heavy-duty, front frame	•	•	•
Cab roof heavy duty	•	•	•
Guards for front headlights	•	•	•
Guards for radiator grill	•	•	•
Guards for tail lights	•	•	•
Windows, side and rear guards	•	•	•
Windshield guard	•	•	•
Corrosion protection, painting of machine	•	•	•
Corrosion protection, painting of attachment bracket	•	•	•
Bucket Teeth protection	•	•	•
<b>Other equipment</b>			
CE-marking	•	•	•
Comfort Drive Control (CDC)	•	•	•
Counterweight, logging	•	•	•
Counter weight, block handling	•	•	•
Counterweight, re-handling	•	•	•
Counterweight, signal painted, chevrons	•	•	•
Log pusher	•	•	•
Secondary steering with automatic test function	•	•	•
Sound decal, EU	•	•	•
Noise reduction kit, exterior	•	•	•
Sign, slow moving vehicle	•	•	•
CareTrack, GSM	•	•	•
CareTrack, GSM/Satellite	•	•	•
<b>Tires</b>			
26.5 R25	•	•	•
29.5 R25	•	•	•
775/65 R29	•	•	•
875/65 R29	•	•	•

# EQUIPMENT.

## OPTIONAL EQUIPMENT

	L150G	L180G	L220G
<b>Attachments</b>			
Buckets:			
• Rock straight or spade nose	•	•	•
• General purpose	•	•	•
• Re-handling	•	•	•
• Side-dump			•
• Light material	•	•	•
Wear parts:			
• Bolt-on and weld-on bucket teeth	•	•	•
• Segments	•	•	•
• Cutting edge in three sections, bolt-on	•	•	•
Fork equipment	•	•	•
Material handling arm	•	•	•
Log grapples	•	•	•

## SELECTION OF VOLVO OPTIONAL EQUIPMENT

Comfort Drive Control (CDC)



Electro-hydraulic 3rd-4th function



Rear-view camera



Boom Suspension System



Fire Suppression System



Automatic Lubrication System









# VOLVO CONSTRUCTION EQUIPMENT

Volvo Construction Equipment is different. Our machines are designed, built and supported in a different way. That difference comes from an engineering heritage of over 175 years. A heritage of thinking first about the people who actually use the machines. About how to help them be safer, more comfortable, more productive. About the environment we all share. The result of that thinking is a growing range of machines and a global support network dedicated to helping you do more. People around the world are proud to use Volvo.

Not all products are available in all markets. Under our policy of continuous improvement, we reserve the right to change specifications and design without prior notice. The illustrations do not necessarily show the standard version of the machine.

# **VOLVO**

**Volvo Construction Equipment**  
[www.volvoce.com](http://www.volvoce.com)

Ref. No 20024203-C  
2012.04  
Volvo, Global Marketing

English-30  
WLO